

Lidar Mapping Report

Acquisition, Processing, and Delivery of Airborne Lidar Elevation Data for CO_CentralEasternPlains_2020_D20

(WU_ID: 211452)

USGS CONTRACT: G16PC00029

CONTRACTOR: Merrick-Surdex Joint Venture, LLP
(MSJV)

TASK ORDER NUMBER: 140G0220F0102

TASK NAME: CO_CentralEasternPlains_2020_D20

- **WP_ID:** 192976
- **WU_ID:** 211452

CLIENT POINT-OF-CONTACT (POC):

Jayna Winehouse
Denver Federal Center, Bld. 810, MS 510
Lakewood, CO 80225
Telephone: 303-202-4502
E-mail: jwinehouse@usgs.gov

Contract Project Manager:

Doug Jacoby
Merrick-Surdex Joint Venture, LLP
5970 Greenwood Plaza Blvd.
Greenwood Village, CO 80111
(303) 353-3903 (o)
(303) 521-6522 (c)
doug.jacoby@Merrick.com

Submitted To



Submitted by:



JOINT VENTURE

Table of Contents

Glossary of Terms	2
Project Summary	4
Project Report	5
Lidar Flight Information	5
Aerial Mission(s)	6
GNSS / IMU Data.....	7
GNSS Controls.....	8
Lidar Calibration – see appendix 1 for a more detailed workflow description.....	8
Relative Accuracy – flight line to flight line.....	8
Unfiltered Lidar Control Point Report.....	9
Lidar Control Point Layout	10
Lidar Filtering and Classification	10
Filtered Lidar Checkpoint Report.....	11
Hydro-flattening Breakline Collection	13
Bare-Earth DEM	14
Intensity Images.....	14
List of Deliverables.....	14
Appendix 1.....	16

Glossary of Terms

Term	Description
AGL	Above Ground Level
AGPS	Airborne Global Positioning System
ANPD	Aggregate Nominal Pulse Density
ANPS	Aggregate Nominal Pulse Spacing
ASPRS	American Society of Photogrammetry and Remote Sensing
AT	Aerial Triangulation
CD	Compact Disk
CMS	Certified Mapping Scientist
CORS	Continuous Operating Reference Station
CP	Certified Photogrammetrist
CVA	Consolidated Vertical Accuracy
DACS™	Digital Airborne Camera System
DEM	Digital Elevation Model
DFIRM	Digital Flood Insurance Rate Maps
DSM	Digital Surface Model
DTM	Digital Terrain Model
DVD	Digital Versatile Disk / Digital Video Disk
DXF	Data Exchange Format / Drawing Interchange
FIRM	Flood Insurance Rate Maps
FEMA	Federal Emergency Management
FGDC	Federal Geographic Data Committee
FVA	Fundamental Vertical Accuracy
FY	Fiscal Year
GIS	Geographic Information System
GISP	Geographic Information System Professional
GNSS	Global Navigation Satellite System
GPS	Global Positioning System
GSD	Ground Sample Distance
HARN	High Accuracy Reference Network
HDD	Hard Drive Disk
HPGN	High Precision Geodetic Network
IMU	Inertial Measurement Unit
INS	Inertial Navigation System
LAS	(or .las) – industry accepted LIDAR data exchange file format
LB	License Business
LS	Land Surveyor
LIDAR	(or Lidar) Light Detection And Ranging
MARS®	Merrick Advanced Remote Sensing
MSJV	Merrick-Surdex Joint Venture, LLP
MSL	Mean Sea Level
NAD	North American Datum
NDEP	National Digital Elevation Program
NGP	National Geospatial Program
NGS	National Geodetic Survey
NMAS	National Map Accuracy Standards
No.	Number
NPS	Nominal Point Spacing

NSRS	National Spatial Reference System
NSSDA	National Standard for Spatial Data
NVA	Non-vegetated Vertical Accuracy
OPUS	Online Positioning User Service
PDOP	Positional Dilution Of Precision
PLS	Professional Land Surveyor
PLSS	Public Land Survey System
ppsm	Points (or pulses) per square meter
PSM	Professional Surveyor and Mapper
QL1	Quality Level One
QL2	Quality Level Two
RLS	Registered Land Surveyor
RGB	Red, Green, Blue (i.e., three-band image)
RGBNIR	Red, Green, Blue, Near Infra-Red (i.e., four-band image)
RMSE	Root Mean Square Error
SBET	Smoothed Best Estimated Trajectory
SHA	Secured Hash Standard
SPCS	State Plane Coordinate System
SVA	Supplemental Vertical Accuracy
TIN	Triangular Irregular Network
USGS	United States Geological Survey
VVA	Vegetated Vertical Accuracy
WP_ID	Work Package ID (USGS)
WU_ID	Work Unit ID (USGS)
XML	eXtensible Markup Language

Project Summary

MSJV was awarded the CO_CentralEasternPlains_2020_D20 Task Order by the United States Geologic Survey (USGS) to provide high resolution data set of QL2 lidar of approximately 9,758.4 square miles of eastern Colorado including the full and partial counties of: Washington, Yuma, Kit Carson, Cheyenne, Crowley, Kiowa and Otero.

The lidar mapping requirements and deliverables meet Quality Level Two (QL2) standards for final deliverables as outlined in the USGS-NGP Lidar Base Specifications, Techniques and Methods 11–B4, Version 2.1, October 2019 (TM11-B4) (<https://www.usgs.gov/3DEP/lidarspec>). QL2 lidar specifications suggest a pulse density of greater than or equal to two pulses per square meter ($\geq 2\text{ppsm}$) Aggregate Nominal Pulse Density (ANPD), and pulse spacing of less than or equal to seventy-one centimeters ($\leq 0.71\text{m}$) Aggregate Nominal Pulse Spacing (ANPS).

The vertical accuracy requirements of the lidar data meets or exceeds the following:

Absolute Vertical Accuracy

- $\leq 10\text{cm}$ RMSEz
- $\leq 19.6\text{cm}$ Non-vegetated Vertical Accuracy (NVA) at the 95% confidence level
- $\leq 30\text{cm}$ Vegetated Vertical Accuracy (VVA) at the 95% percentile

Relative Vertical Accuracy

- $\leq 6\text{cm}$ within individual swaths (smooth surface repeatability)
- $\leq 8\text{cm}$ RMSD_z within swath overlap (between adjacent swaths)

Project Spatial Reference

- Horizontal Datum – North American Datum of 1983 (NAD 83)
- Epoch – National Adjustment of 2011 (NA2011) (epoch 2010.00)
- Geoid – GEOID 2018
- Vertical Datum – North American Vertical Datum of 1988 (NAVD 88)
- Projection – Universal Transverse Mercator (UTM), Zone 13 North (13N)
- Units – Meters

CONTACT INFORMATION

Questions regarding this report should be addressed to:

Doug Jacoby, CMS, GISP

Program Manager

Merrick-Surdex Joint Venture, LLP

5970 Greenwood Plaza Blvd.

Greenwood Village, CO 80111

T: +1 303-353-3903

Doug.jacoby@Merrick.com

Project Report

The contents of this report summarize the methods used to calibrate and classify the lidar data as well as the results of these methods for the CO_CentralEasternPlains_2020_D20 Task Order, otherwise known as WP_ID 192976. Results of this report are given for the delineated WU_ID 211452.

Lidar Flight Information

The acquisition area for the CO_CentralEasternPlains_2020_D20 Task Order is delineated by the extent of the client approved Esri shapefile (*CO_CentralEasternPlains_2020_D20_UTM_AOI_100mBuff_DPA_UpdatedAOI_04062020.shp*). MSJV acquired the QL2 lidar point cloud utilizing Optech Galaxy PRIME lidar sensors. The Galaxy is a high performance lidar sensor capable of collecting large areas efficiently. The project was flown and then processed and delivered in sections (Work Units).

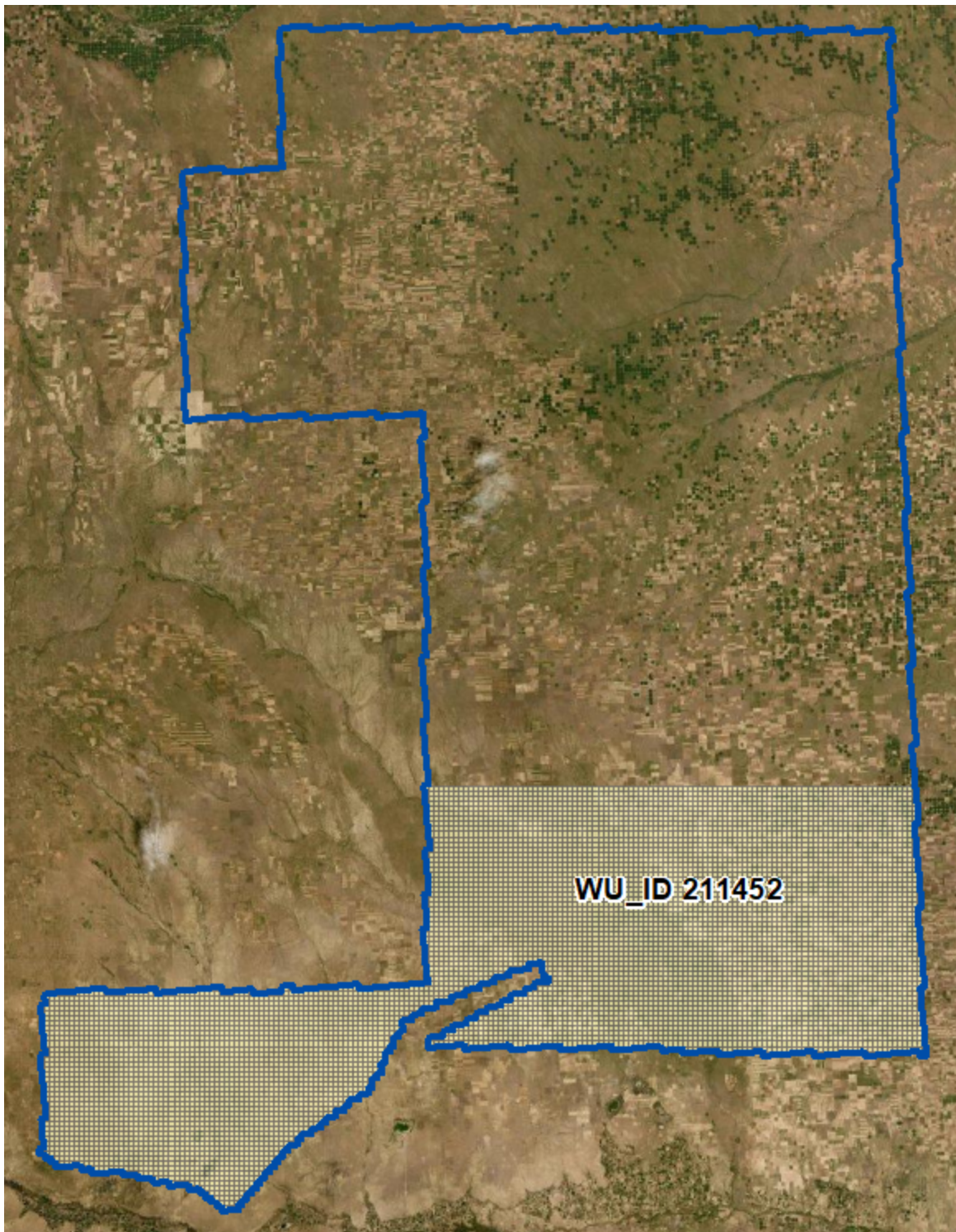

Aerial Mission(s)

Lidar acquisition was collected using fixed wing aircraft and Optech Galaxy PRIME lidar sensors staging from a variety of airports around the project area. Lidar data collection for WU_ID 211452 was accomplished between May 12, 2020 and September 6, 2020. Each mission represents a lift of the aircraft and system from the ground, collects data, and lands again. Multiple lifts within a day are represented by Mission A, B, C, and D. The table

below relates each mission to the date collected, the sensor and serial number used, and the actual average MSL in meters.

Mission(s)	Date	Sensor S/N	Actual Avg. MSL (m)
200512_A	May 12, 2020	5060428	4151
200513_A	May 13, 2020	5060428	3952
200513_B	May 13, 2020	5060428	4119
200513_A	May 13, 2020	5060420	4215
200514_A	May 14, 2020	5060420	4114
200517_A	May 17, 2020	5060420	4034
200517_A	May 17, 2020	5060428	4065
200518_A	May 18, 2020	5060420	4048
200518_B	May 18, 2020	5060420	4006
200519_A	May 19, 2020	5060420	4015
200519_B	May 19, 2020	5060420	4039
200522_A	May 22, 2020	5060420	4058
200530_A	May 30, 2020	5060420	4042
200530_B	May 30, 2020	5060420	4101
200625_A	June 25, 2020	5060428	3955
200626_A	June 26, 2020	5060428	3987
200627_A	June 27, 2020	5060428	3944
200627_B	June 27, 2020	5060428	3994
200906_A	September 6, 2020	5060442	4020
200906_B	September 6, 2020	5060442	4079

GNSS / IMU Data

During the data collection, the operator recorded information on log sheets which includes weather conditions, lidar operation parameters, and flight line statistics. Data is sent back to the main office for preliminary processing to check overall quality of GNSS / INS data and to ensure sufficient overlap between flight lines. Any problematic data may be re-flown immediately as required.

The airborne GNSS data was post-processed using Applanix POSPac Mobile Mapping Suite version 8.x. A fixed-bias carrier phase solution was computed in both the forward and reverse chronological directions. Whenever practical, lidar acquisition was limited to periods when the PDOP was less than 4.0. PDOP indicates satellite geometry relating to position. Generally, PDOP's of 4.0 or less result in a good quality solution, however PDOP's between 4.0 and 5.0 can still yield good results most of the time. PDOP's over 6.0 are of questionable results and PDOP's of over 7.0 usually result in a poor solution. Usually as the number of satellites increase the PDOP decreases. Other quality control checks used for the GNSS include analyzing the combined separation of the forward and reverse GNSS processing from one base station and the results of the combined separation when processed from two different base stations. An analysis of the number of satellites, present during the flight and data collection times, is also performed.

The GNSS trajectory was combined with the raw IMU data and post-processed using POSPac Mobile Mapping Suite version 8.x. The SBET and refined attitude data are then utilized in the LMS Post Processor to compute the laser point-positions – the trajectory is combined with the attitude data and laser range measurements to

produce the 3-dimensional coordinates of the mass points. Up to four return values are produced within the Optech LMS processor software for each pulse which ensures the greatest chance of ground returns in a heavily forested area.

GNSS Controls

Virtual Ground GNSS Base Station(s) were used to control the lidar airborne flight lines. Trimble CenterPoint™ RTX™ correction service is a high-accuracy, satellite-delivered global positioning service. This technology provides high-accuracy GNSS positioning without the use of traditional reference station-based differential RTK infrastructure and delivers very high cm level accuracy. In addition, CORS (Continually Operating Reference Stations) are at times used to further enhance the airborne solution.

Lidar Calibration – see appendix 1 for a more detailed workflow description

MSJV takes great care to ensure all lidar acquisition missions are carried out in a manner conducive to post-processing an accurate data set. This begins in the flight-planning stage with attention to GNSS baseline distances and GNSS satellite constellation geometry and outages. Proper AGPS surveying techniques are always followed including pre- and post-mission static initializations. In-air IMU alignments (figure-eights) are performed both before and after on-site collection to ensure proper calibration of the IMU accelerometers and gyros.

A minimum of one cross-flight is planned throughout the project area across all flightlines and over roadways where possible. The cross-flight provides a common control surface used to remove any vertical discrepancies in the lidar data between flightlines. The cross-flight is critical to ensure flightline ties across the project area. The areas of overlap between flightlines are used to boresight (calibrate) the lidar point cloud to achieve proper flightline to flightline alignment in all three axes. This includes adjustment of both IMU and scanner-related variables such as roll, pitch, heading, timing interval (range), and torsion. Each lidar mission flown is accompanied by a hands-on boresight in the office.

After boresighting is complete a detailed statistical report is generated to check relative and absolute accuracies before filtering of lidar begins.

Relative Accuracy – flight line to flight line

The project representative flight line separation raster (below) depicts the vertical separation of flight lines by thematically coloring the separation magnitude on a color ramp based on relative distance.

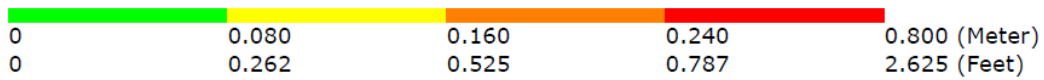
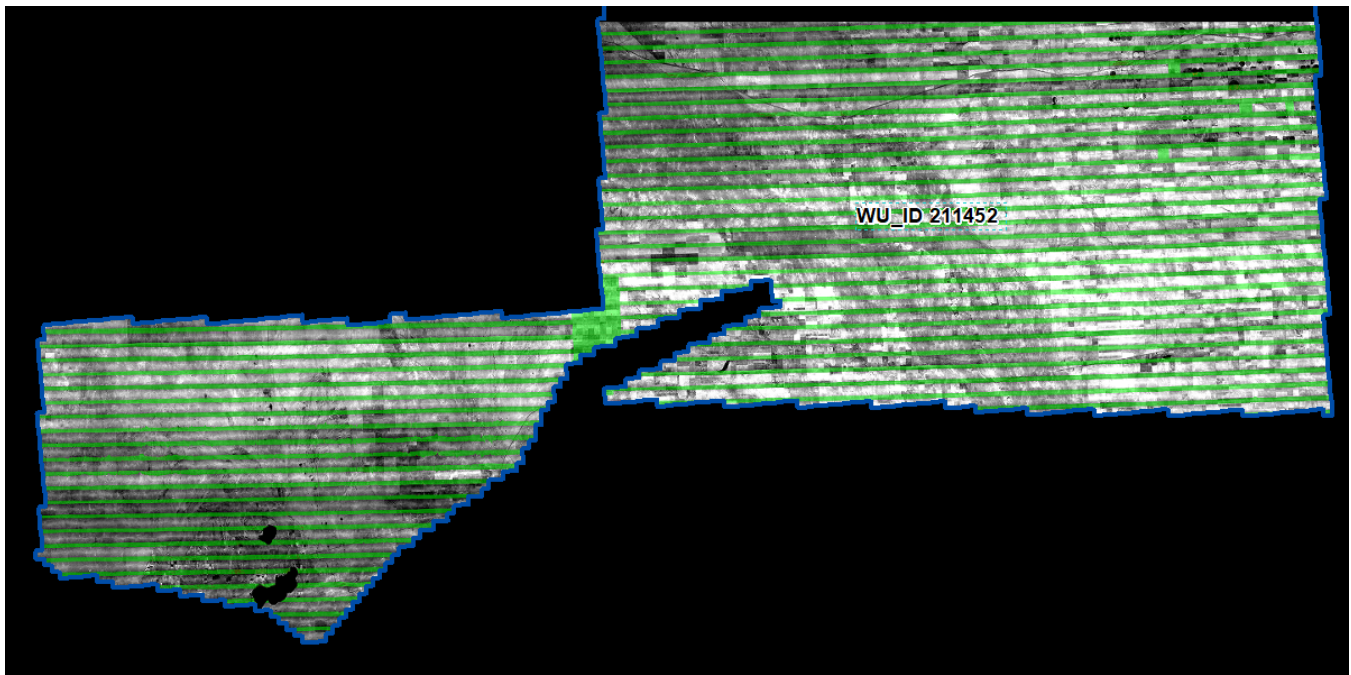

Unfiltered Lidar Control Point Report

The following statistical results of the lidar data compared to the lidar control points post-calibration. The results show the difference between the lidar points and the 38 surveyed ground points located in WU_ID 211452.

Project Data Unit: Meter
 Vertical Accuracy Class tested: 10.0-cm
 Elevation Calculation Method: Interpolated from TIN
 LiDAR Classifications Included: 0-255

Check Points in Report: 38
 Check Points with LiDAR Coverage: 38
 Check Points (NVA): 38
 Check Points (VVA): 0
 Average Vertical Error Reported: 0.018 Meter
 Maximum (highest) Vertical Error Reported: 0.143 Meter
 Median Vertical Error Reported: 0.006 Meter
 Minimum (lowest) Vertical Error Reported: -0.074 Meter
 Standard deviation of Vertical Error: 0.055 Meter
 Skewness of Vertical Error: 0.523
 Kurtosis of Vertical Error: -0.423
 Non-vegetated Vertical Accuracy (NVA) RMSE(z): 5.705cm PASS
 Non-vegetated Vertical Accuracy (NVA) at the 95% Confidence Level +/-: 11.183cm PASS
 FGDC/NSSDA Vertical Accuracy at the 95% Confidence Level +/-: 11.183cm
 Non-vegetated Vertical Accuracy (NVA) RMSE(z) (DEM): 5.590cm PASS
 Non-vegetated Vertical Accuracy (NVA) at the 95% Confidence Level +/- (DEM): 10.956cm PASS

This data set was tested to meet ASPRS Positional Accuracy Standard for Digital Geospatial Data (2014) for a 10.0-cm RMSEz Vertical Accuracy Class. Actual NVA accuracy was found to be RMSEz = 5.705cm, equating to +/- 11.183cm at the 95% confidence level.

Lidar Control Point Layout

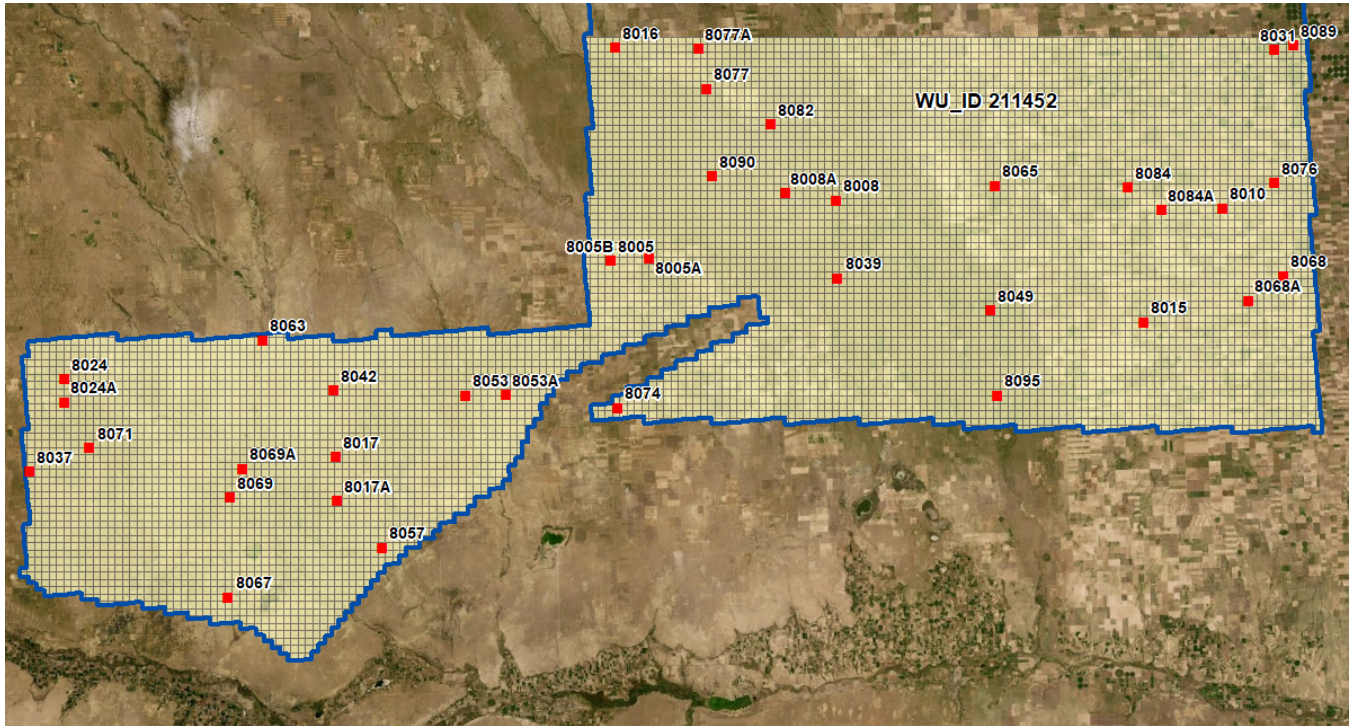

Lidar Filtering and Classification

The lidar filtering process encompasses a series of automated and manual steps to classify the boresighted point cloud data set. Each project represents unique characteristics in terms of cultural features (urbanized vs. rural areas), terrain type and vegetation coverage. These characteristics are thoroughly evaluated at the onset of the project to ensure that the appropriate automated filters are applied and that subsequent manual filtering yields correctly classified data. Data is most often classified by ground and “unclassified”, but specific project applications can include a wide variety of classifications including but not limited to buildings, vegetation, power lines, etc. MARS® software is used for the auto-filtering, manual filtering and QC of the classified data.

MSJV used the ASPRS LAS Specification Version 1.4 – R13, 15 July 2013, Point Data Record Format 6 for this project and classified the lidar point cloud in accordance with the following classification classes and bitflags. The following outlines project specific requirements.

- Class 1 = Unclassified
- Class 2 = Bare-earth Ground
- Class 7 = Low point (noise)
- Class 9 = Water
- Class 17 = Bridge decks
- Class 18 = High noise
- Class 20 = Ignored Ground (breakline proximity)
- Class 21 = Snow (if present and identifiable)
- Class 22 = Temporal exclusion (typically non-favored data in intertidal zones)

- Bitflags

- Overlap: Any part of a swath that also is covered by any part of any other swath.
- Withheld: Within the LAS file specification, a single bit flag indicating that the associated lidar point is geometrically anomalous or unreliable and should be ignored for all normal processes.

MSJV has developed several customized automated filters that are applied to the lidar data set based on project specifications, terrain, and vegetation characteristics. A filtering macro, which may contain one or more filtering algorithms, is executed to derive LAS files separated into the different classification groups as defined in the ASPRS classification table. The macros are tested in several portions of the project area to verify the appropriateness of the filters. Often, there is a combination of several filter macros that optimize the filtering based on the unique characteristics of the project. Automatic filtering generally yields a ground surface that is 85-90% valid, so additional editing (hand-filtering) is required to produce a more robust ground surface.

Lidar data is next taken into a graphic environment using MARS® to manually re-classify (or hand-filter) “noise” and other features that may remain in the ground classification after auto filter. A cross-section of the post auto-filtered surface is viewed to assist in the reclassification of non-ground data artifacts. The following is an example of re-classification of the non-ground points (elevated features) that need to be excluded from the true ground surface. Certain features such as berms, hilltops, cliffs and other features may have been aggressively auto-filtered and points will need to be re-classified into the ground classification. Data in the profile view displays non-ground (Unclassified, class 1) in grey and ground in brown/tan (Class 2). In **Figure 1**, a small building was not auto-filtered and needs to be manually re-classified. Note that **Figure 2** has the building points reclassified to unclassified from the true ground surface.

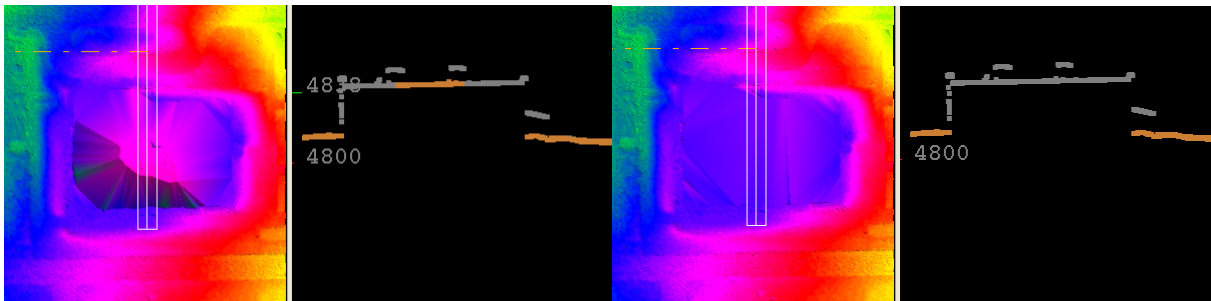

Figure 1

Figure 2

A combination of automated and semi-automated routines to classify buildings and vegetation. We expect that the classified buildings will meet a filtering criterion in the range of 90-95%.

At this point, individual lidar points from the original point cloud have now been parsed into separate classifications.

Filtered Lidar Checkpoint Report

After hand-filtering has been completed and quality checked, a Checkpoint Report is generated to validate that the accuracy of the ground surface is within the defined accuracy specifications. Each surveyed ground check point is compared to the lidar surface by interpolating an elevation from a Triangulated Irregular Network (TIN) of the surface. The MARS® derived report provides an in-depth statistical report, including an RMSE of the vertical errors; a primary component in most accuracy standards and a statistically valid assessment of the overall accuracy of the ground surface.

The below lidar check point reports provide statistics for 121 ground survey checkpoints (70 NVA, 51 VVA) used to validate the final filtered lidar surface.

Units: Meter (/Feet)

Vertical Accuracy Class tested: 10-cm

Check Points in defined project area (DPA):	121
Check Points with Lidar Coverage	121
Check Points with Lidar Coverage (NVA)	70
Check Points with Lidar Coverage (VVA)	51
Average Z Error (NVA)	0.034/0.113
Maximum Z Error (NVA)	0.191/0.625
Median Z Error (NVA)	0.026/0.086
Minimum Z Error (NVA)	-0.153/-0.500
Standard deviation of Vertical Error (NVA)	0.063/0.208
Skewness of Vertical Error (NVA)	0.243
Kurtosis of Vertical Error (NVA)	0.520
Non-vegetated Vertical Accuracy (NVA) RMSE(z) ¹	0.072/0.236 PASS
Non-vegetated Vertical Accuracy (NVA) at the 95% Confidence Level +/- ¹	0.141/0.462 PASS
FGDC/NSSDA Vertical Accuracy at the 95% Confidence Level +/-	0.141/0.462
Non-vegetated Vertical Accuracy (NVA) RMSE(z) (DEM) ²	0.071/0.234 PASS
Non-vegetated Vertical Accuracy (NVA) at the 95% Confidence Level (DEM) +/- ²	0.140/0.459 PASS
Vegetated Vertical Accuracy (VVA) at the 95th Percentile (TIN) +/- ¹	0.267/0.874 PASS
Vegetated Vertical Accuracy (VVA) at the 95th Percentile (DEM) +/- ²	0.265/0.868 PASS

This data set was tested to meet ASPRS Positional Accuracy Standard for Digital Geospatial Data (2014) for a 10-cm RMSEz Vertical Accuracy Class. Actual NVA accuracy was found to be RMSEz = 7.2cm, equating to +/- 14.1cm at the 95% confidence level. Actual VVA accuracy was found to be +/- 26.5cm at the 95th percentile.

¹ This value is calculated from TIN-based testing of the lidar point cloud data.

² This value is calculated from RAM-based grid testing of the lidar data. The grid cells are sized according to the Quality Level selected, and are defined in the USGS NGP Lidar Base Specification Version 2.1 (Table 6).

Lidar Checkpoint Layout

- ▲ NVA
- VVA

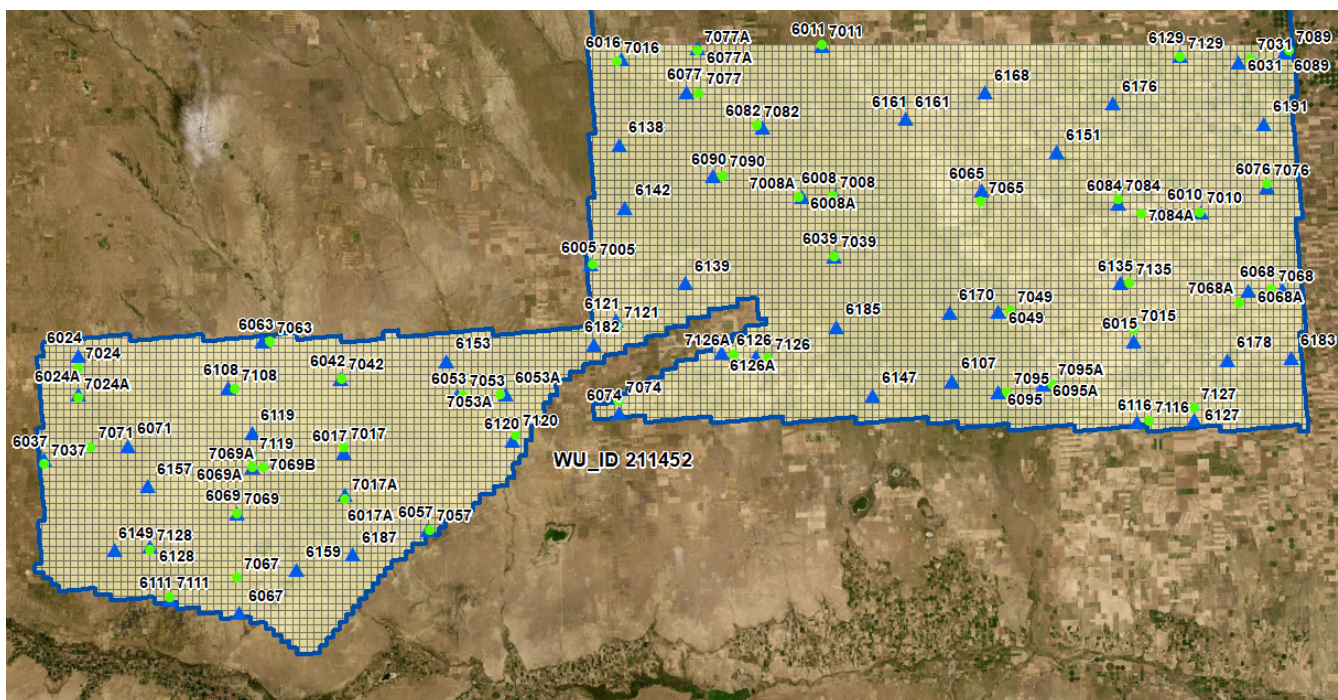

Hydro-flattening Breakline Collection

Hydro- flattening breaklines are captured per the USGS National Geospatial Program Lidar Base Specification Version 2.1. Final hydro-flattened breaklines features are appropriately turned into polygons (flat elevations) and polylines (decreasing by elevation) and are used to reclassify ground points in water to Water (Class 9). The lidar points around the breaklines are reclassified to Ignored Ground (Class 10) based on predetermined buffer.

The next step in the process is the hydro-flattening breakline collection required for the development of the hydro-flattened DEMs. MSJV will capture hydro-flattening breaklines for waterbodies greater than or equal to two (≥ 2) acres; double-sided streams and rivers that are greater than or equal to one hundred feet ($\geq 100'$), and; any visible islands greater than or equal to one (≥ 1) acres. Criteria for Tidal Waters are assumed not applicable. No single-line streams or drainages will be collected, nor will any planimetric features that could be utilized as traditional breaklines. All downstream hydro-flattening breaklines require monotonicity (e.g., streams and rivers). Closed polygonal boundaries of water will maintain a fixed (i.e., flat) elevation. Breaklines are not required to conform to the EleHydro Breakline GIS Data Dictionary for this Task Order.

Linear hydrographic features

To collect hydrographic features, MSJV uses a methodology that directly interacts with the lidar bare-earth data to collect drainage breaklines. To determine the alignment of a drainageway, the technician first views the area as a TIN of bare-earth points using a color ramp to depict varying elevations. In areas of extremely flat terrain, the technician may need to determine the direction of flow based on measuring lidar bare-earth points at each end of the drain. The operator will then use the color ramped TIN to digitize the drainage in 2D with the elevation being attributed directly from the bare-earth LAS data. MARS® software has the capability of “flipping” views between the elevation TIN, Intensity and imagery, as necessary, to further assist in the determination of the drainage. All drainage breaklines are collected in a downhill direction. For each point collected, the software uses a five-foot (5') search radius to identify the lowest point within that proximity. Within each radius, if a bare-earth point is not found that is lower than the previous point, the elevation for subsequent point remains the same as the previous point. This forces the drain to always flow in a downhill direction. Waterbodies that are embedded along a drainageway are validated to ensure consistency with the downhill direction of flow.

This methodology may differ from those of other vendors in that MSJV relies on the bare-earth data to attribute breakline elevations. As a result of our methodology, there is no mismatch between lidar bare-earth data and breaklines that might otherwise be collected in stereo 3D as a separate process. This is particularly important in densely vegetated areas where breaklines collected in 3D from imagery will most likely not match (either horizontally or vertically), the more reliable lidar bare-earth data.

MSJV has the capability of “draping” 2D breaklines to a bare-earth elevation model to attribute the “z” as opposed to the forced downhill attribution methodology described above. However, the problem with this process is the “pooling” effect or depressions along the drainageway caused by a lack of consistent penetration in densely vegetated areas.

Criteria of linear hydrographic breaklines are as follows:

- Linear hydrographic features (e.g., visible streams, rivers, shorelines, canals, etc.) greater than or equal to one hundred feet ($\geq 100'$) wide will be captured as a double-lined polygon
 - linear hydrographic features must be flat and level bank-to-bank (perpendicular to the apparent flow centerline) with gradient following the immediately surrounding terrain
 - water surface edge must be at or just below the immediately surrounding terrain
 - streams should break at road crossings (e.g., culverts), and streams and rivers should not break at bridges

Waterbodies

Waterbodies are digitized from the color ramped TIN, similar to the process described above. The elevation attribute is determined as the technician collects the hydro feature by using the lowest bare-earth point within the polygon.

Criteria of waterbody breaklines are as follows:

- Waterbodies (e.g., lakes, ponds, reservoirs) greater than or equal to two (≥ 2) acres in size are surrounded by a water breakline (i.e., closed polygon)
 - waterbodies must be flat and level with a single elevation for every bank vertex
 - water surface edge must be at or just below the immediately surrounding terrain
 - long impoundments, such as reservoirs or inlets, whose water surface elevations drop when moving downstream should be treated as rivers

Color cycles provide a clear indication of where breaklines are to be collected, especially hydrographic breaklines. **Figure 3** demonstrates no breaklines, where **Figure 4** is breakline enforced displayed using color cycles within the MARS® software environment.

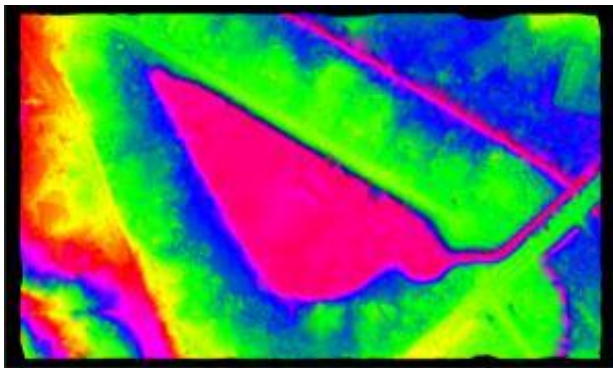

Figure 3

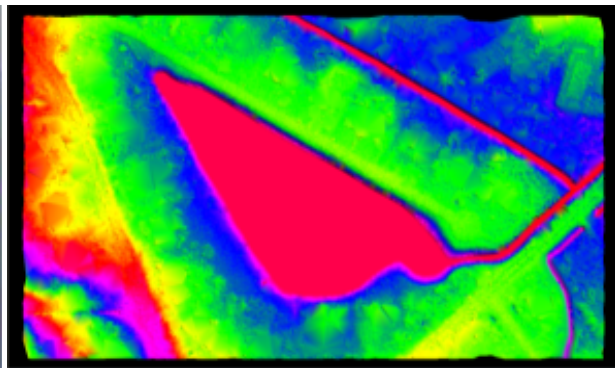

Figure 4

Bare-Earth DEM

MSJV exports the hydro-flattening breakline enforced Class 2 (ground) lidar points to a one-meter (1m) cell size, 32-bit format using MARS®, the DEMs are exported to the project tiling scheme. Projection information is applied that reflects the project requirements.

Intensity Images

MSJV exports all lidar points to a one-meter (1m) cell size 8-bit client desired format using MARS®, the intensity images are exported to the project tiling scheme and / or project-wide boundary. Projection information is applied that reflects the project requirements.

List of Deliverables

- ❖ Classified lidar point cloud
 - Fully compliant ASPRS LAS 1.4-R13 (ASPRS, 2011), point record format 6
 - By tile
 - Intensity values normalized (rescaled) to 16-bit
- ❖ Bare-earth DEM
 - 1m cell size 32-bit floating point raster in cloud optimized GeoTIFF (.tif) format
 - Bare-earth (hydro-flattened)
 - Culverts will not be removed from the DEMs

- Bridges will be removed from the DEMs
- By tile
- ❖ Hydro-flattened breaklines
 - Project-wide Esri feature class(es) for insertion into file geodatabase
 - PolylineZ
 - PolygonZ
- ❖ Intensity Images
 - 1m cell size 8-bit, 256 color gray scale in cloud optimized GeoTIFF (.tif) format
 - By tile
- ❖ FGDC-compliant metadata in XML format
 - LAS
 - DEM
 - Breaklines
 - Intensity
- ❖ Esri shapefiles
 - Flight index
 - Esri feature class(es) for insertion into file geodatabase
 - 1,000m x 1,000m tiles
 - DPA
 - Calibration control
 - NVA / VVA lidar checkpoints
 - Raw swath
- ❖ MARS® QC folder
 - PDF QC reports
 - Miscellaneous files
 - Includes height separation rasters
- ❖ Lidar and Mapping Report
 - Acquisition
 - Processing
 - Accuracy assessment
- ❖ Ground Control Survey Report
 - Collection
 - Processing
 - Coordinate listing (all points)
 - Photos (all points)
 - Shapefiles of coordinates (all points)

Appendix 1

Following is a more detailed lidar calibration workflow description.

LIDAR CALIBRATION AND BLOCK LAS OUTPUT

Note: All figures represented on the following pages are for general illustration purposes, and are not examples derived from the project.

Initial Processing

Lidar data is output as LAS point data using Optech's Lidar Mapping Suite (LMS). LMS matches ground and roof planes plus roof lines to self-calibrate and correct system biases. These biases occur within the hardware of the laser scanning systems, within the Inertial Measurement Unit (IMU) and because of environmental conditions which affect the refraction of light. The systemic biases that are corrected for include scale, roll, pitch, and heading.

In addition to the self-calibration mode LMS runs a "production" mode which applies the self-calibration parameters and then analyzes each individual flight line and applies small adjustments to each line to tie overlapping lidar points even more tightly together.

Boresight Self-Calibration Processing Procedures

An LMS boresight calibration is performed on an as-needed basis to correct scale, roll, pitch and heading biases. A minimum of three overlapping flights are flown in opposing directions with one cross flight.

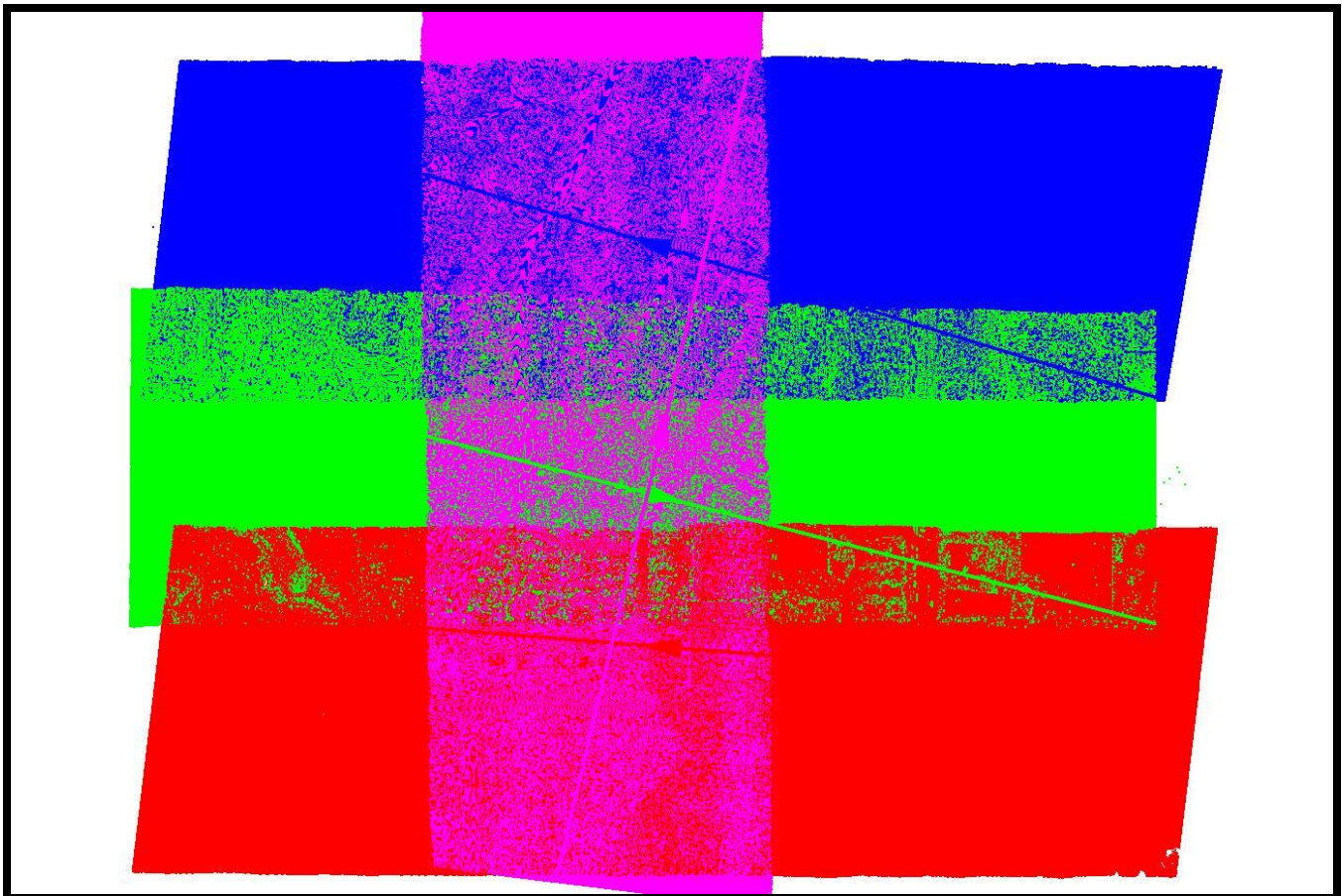

The Boresighting module frees scan angle scale, scan angle lag, XYZ boresight corrections and elevation position corrections while locking scan angle offset and XY position corrections.

The picked calibration site will have a good distribution of buildings for the self-calibration software to match ground planes, roof planes and roof lines.

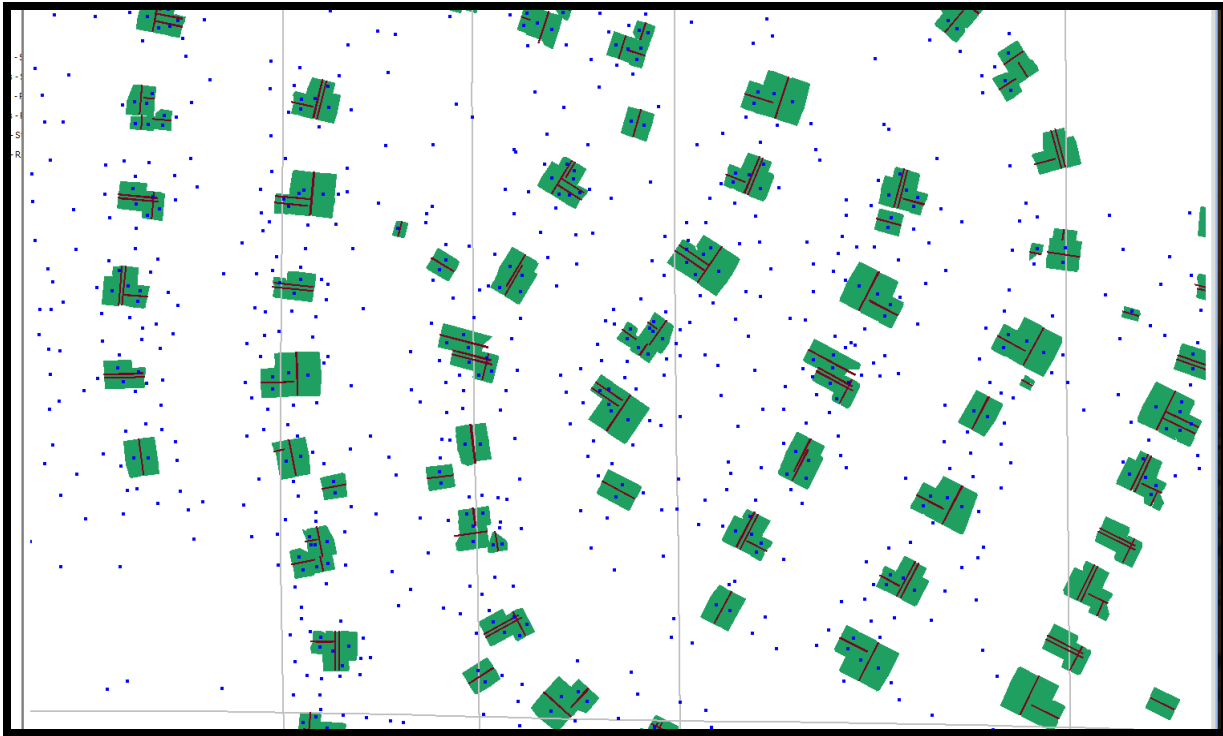

At the conclusion of the self-calibration run the data is quality checked with LMS plots

Plot of plane vertical distances from datum plane.

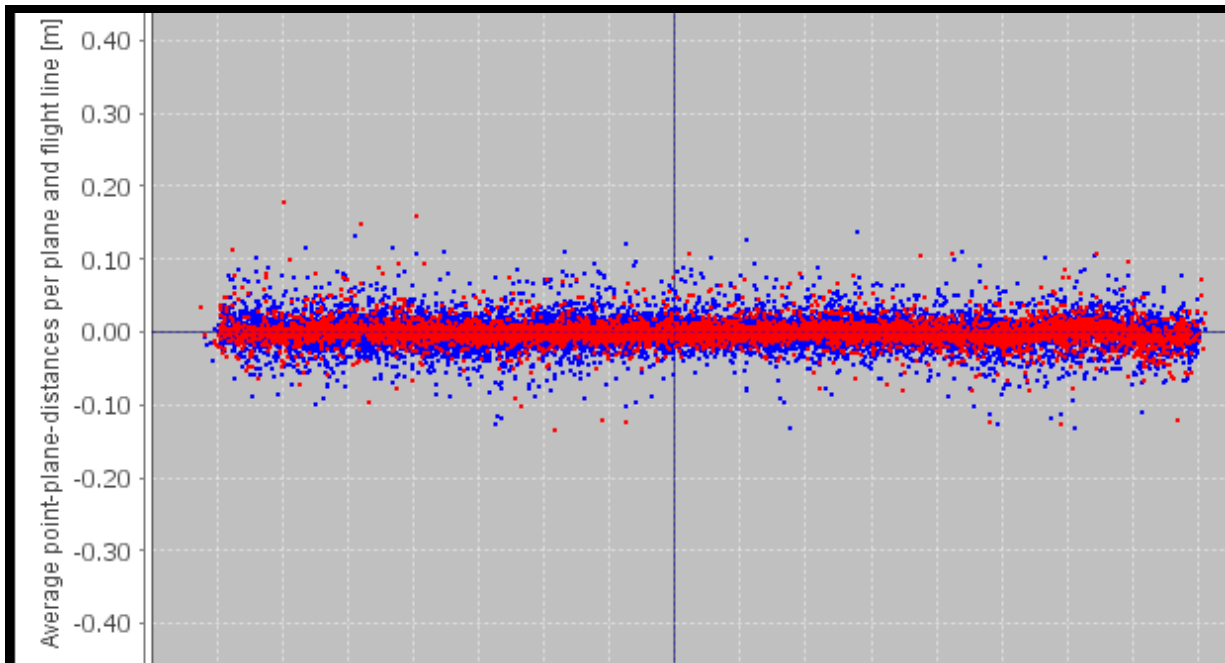

Plot of height differenced between flight lines. (Green=less than 5cm).

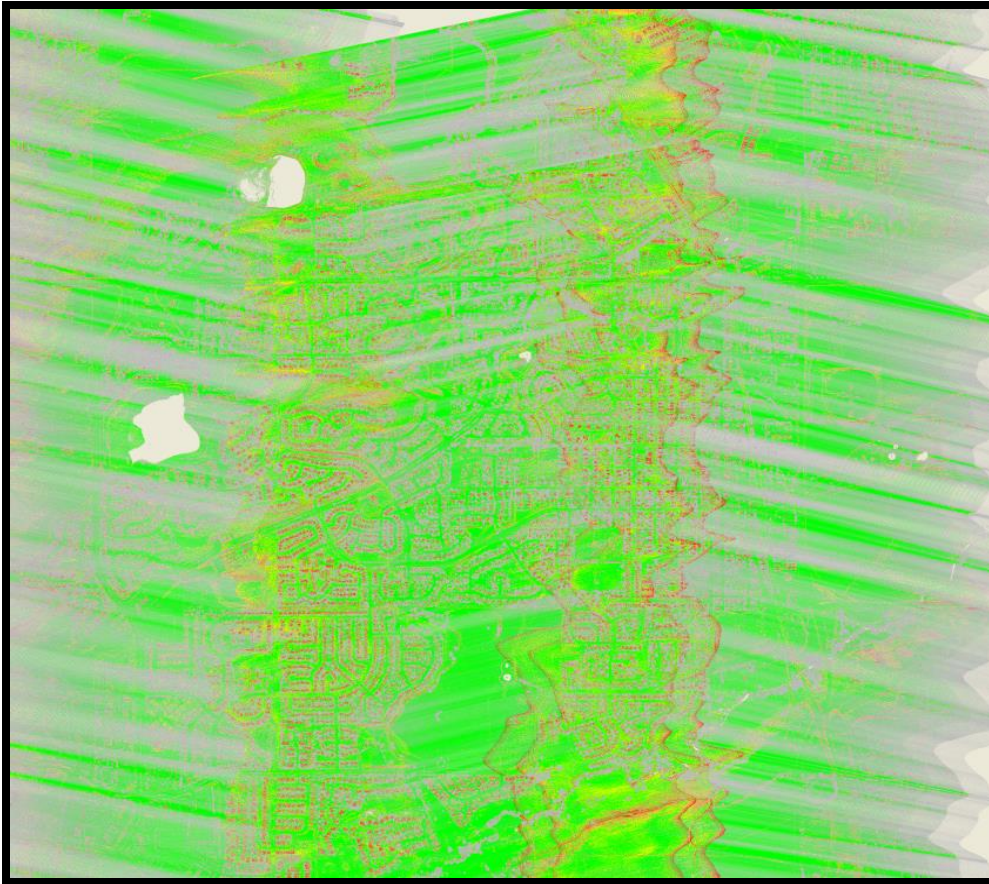

Plot of point densities. (Red=5-9 points per cell, green 10+ points per cell).

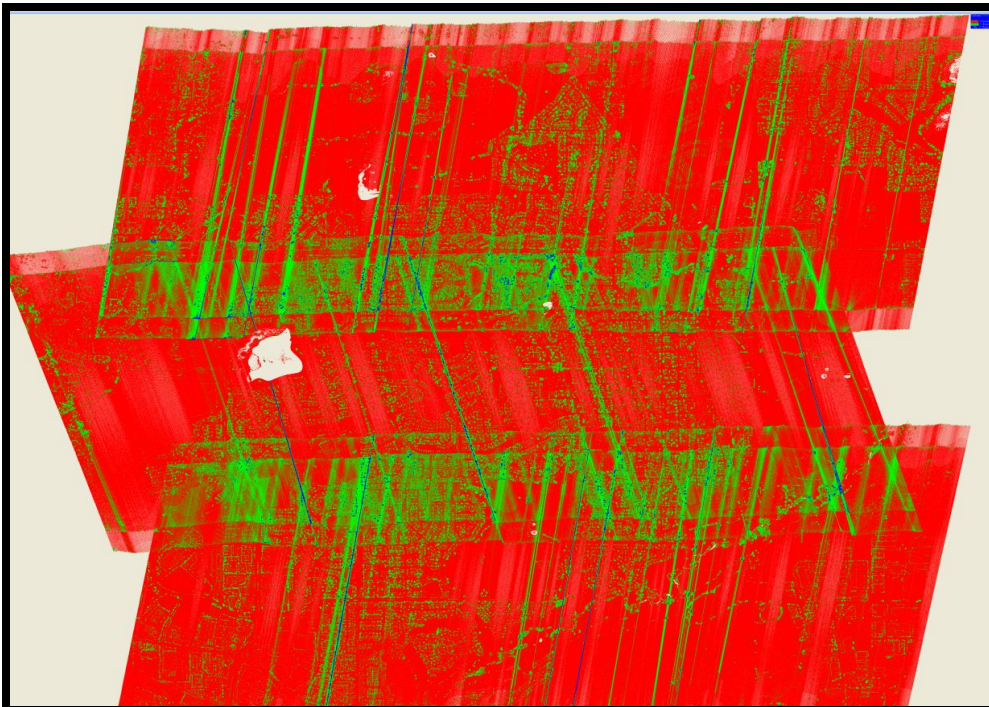

A Flight Line Separation Raster image is generated in Merrick Advanced Remote Sensing Software (MARS®), in this example ground returns from multiple flight lines that are fitting within 3 centimeters are colored green.

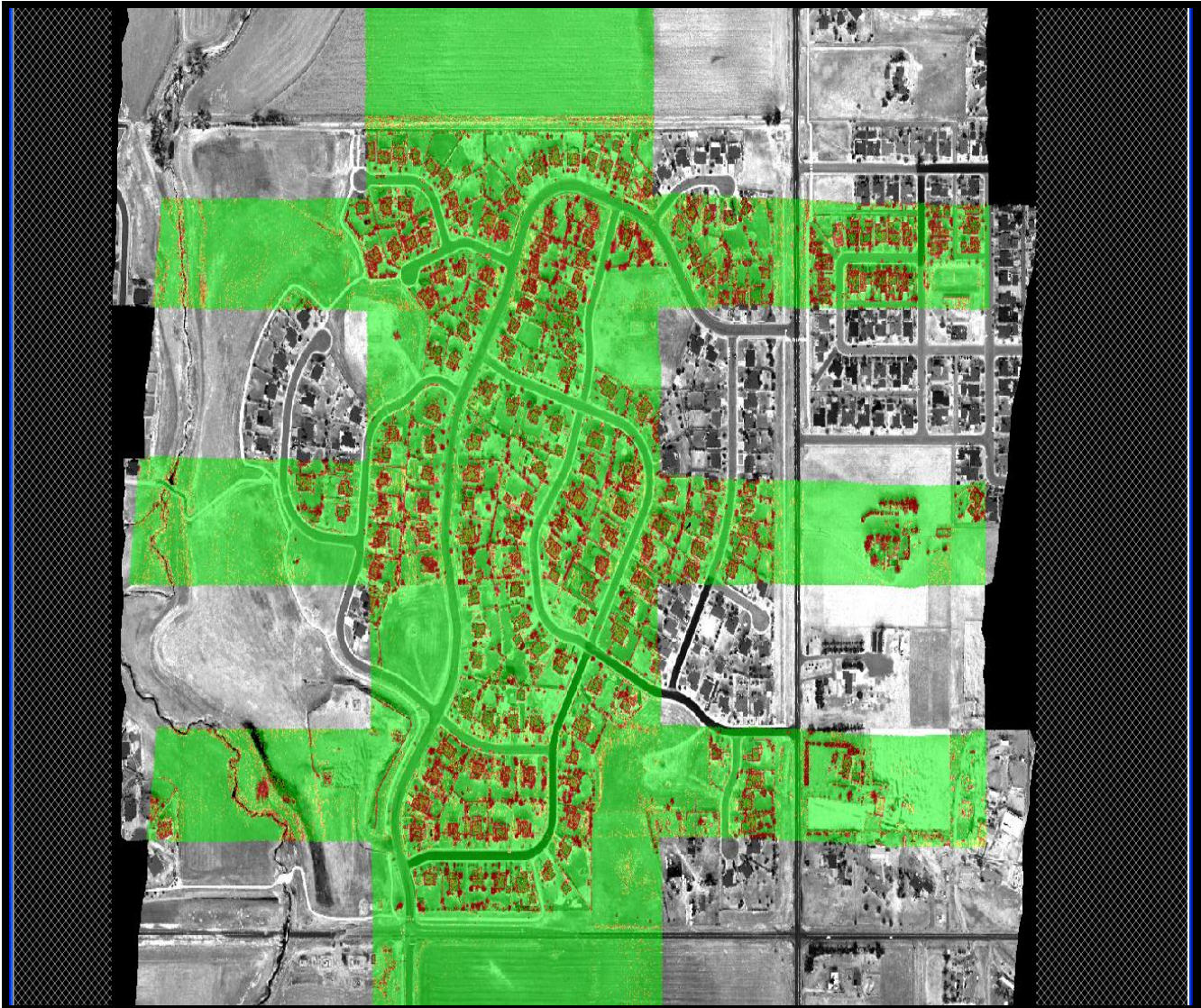

MARS® tests for internal relative vertical accuracy using inbound and outbound scan values. Again, Green is showing inbound and outbound scan data fitting to 3 centimeters.

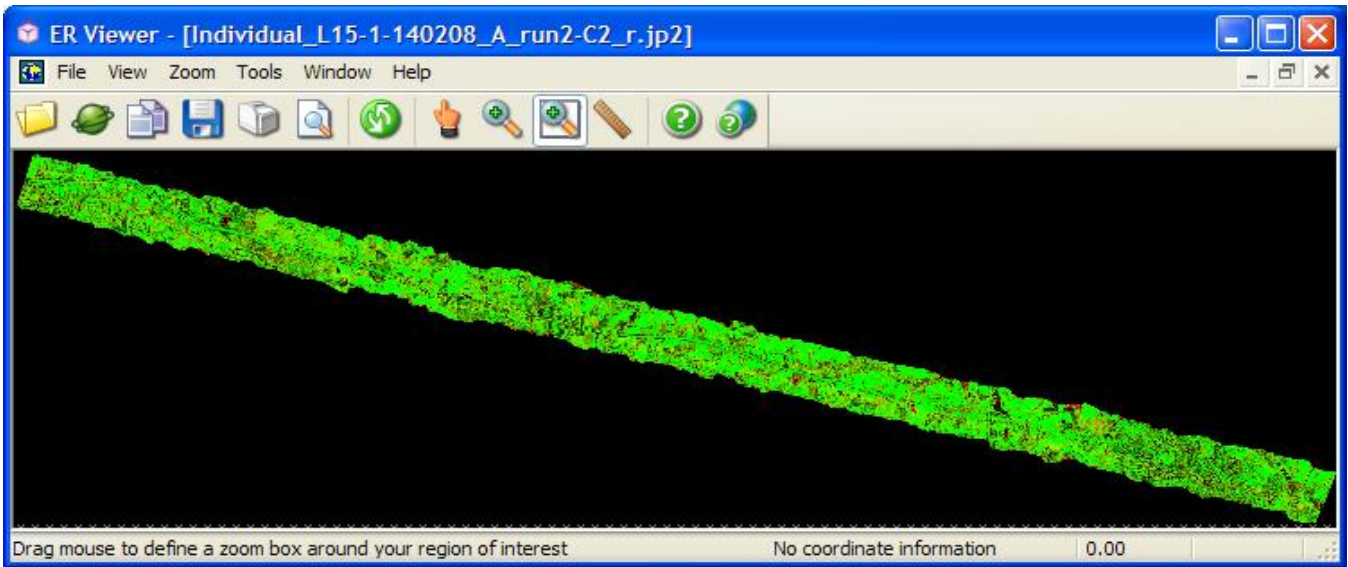

Building cross sections are checked for good alignment. Pitch and heading are checked on roof planes parallel to the flight direction.

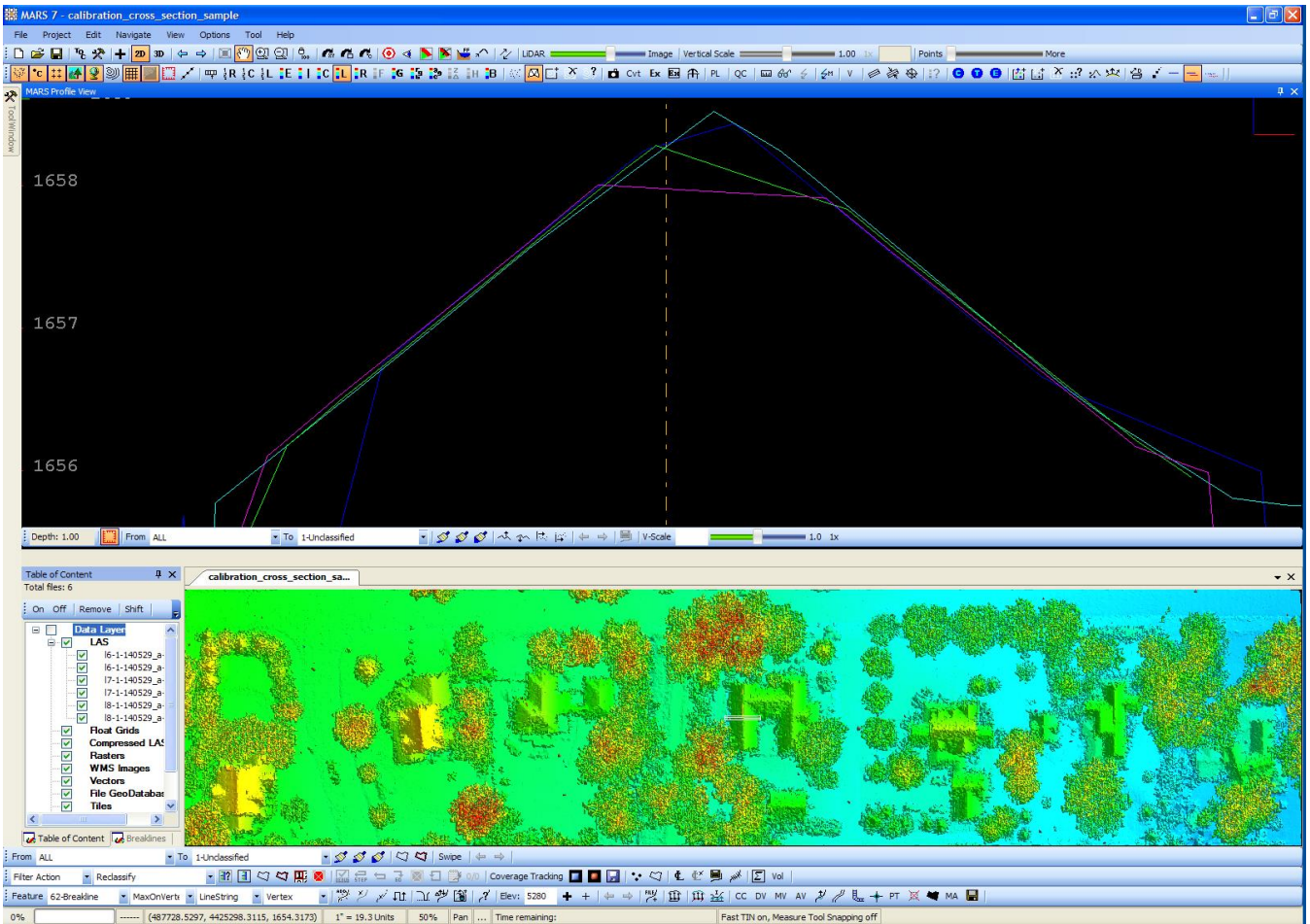

Roll and scale are checked on roof planes perpendicular to the flight direction.

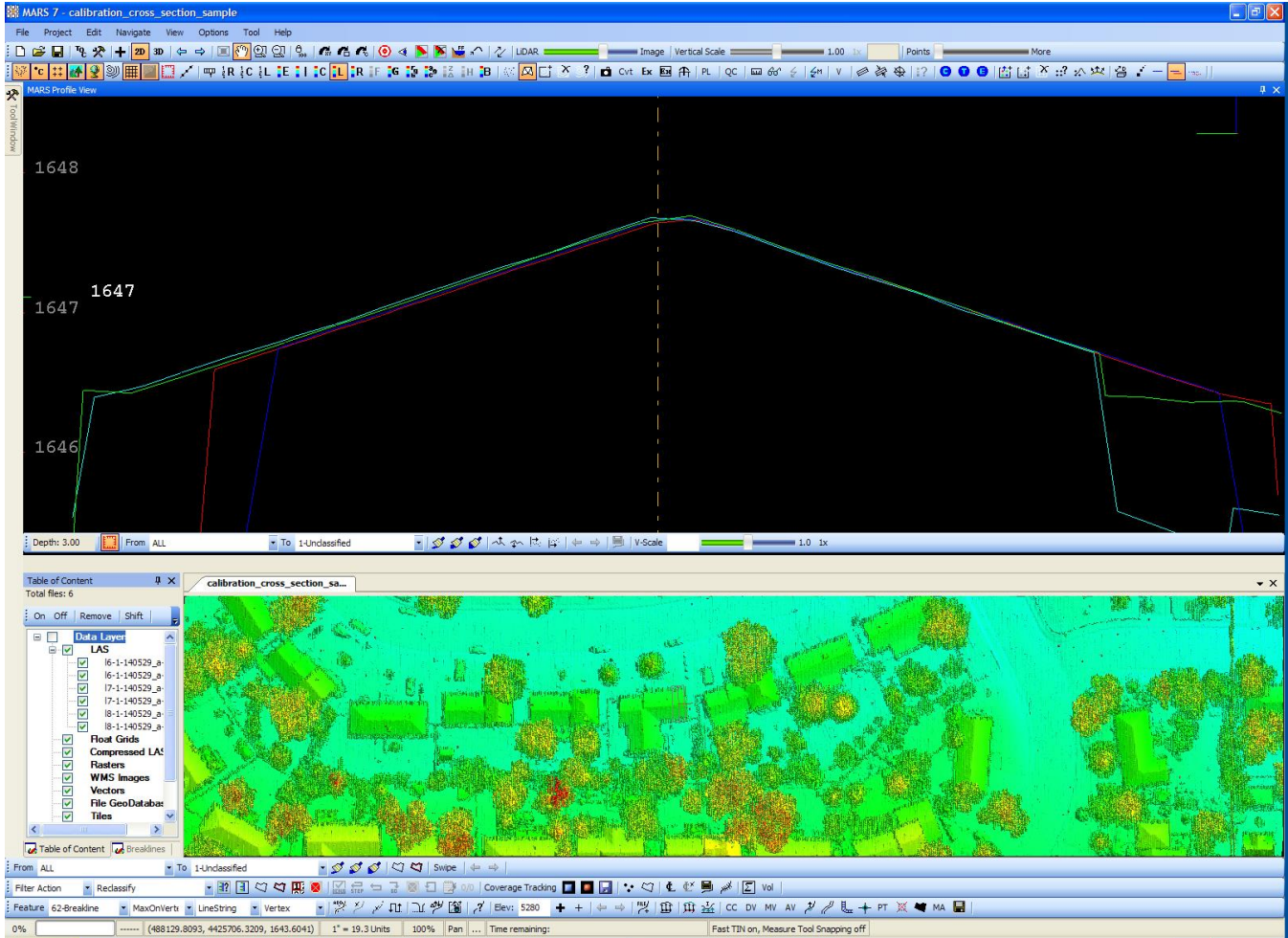

The LMS program outputs a "LCP" file with all the correction parameters. The calibration process may be run several times until the boresight adjustments are acceptable. When the boresight solution is acceptable the LCP file adjustments are saved and also applied to subsequent projects. Each new project is again analyzed and when the adjustment biases show too much drift a new boresight calibration is run. The LCP file may hold calibration tolerances for several projects.

Block LAS Production Processing Procedures

The LMS production mode is run on each flight line to further tie the final lidar LAS flight line files tightly together. Production settings allow scan angle scale, scan angle lag to float and allows elevation to move slightly during flight line to flight line comparison thus further tying flight lines together. A cross flight with locked elevation data is used for controlling flight line elevations.

A block of data is selected to process with LMS production settings. Data collected during turns at the ends of flight lines is deselected (light blue lines).

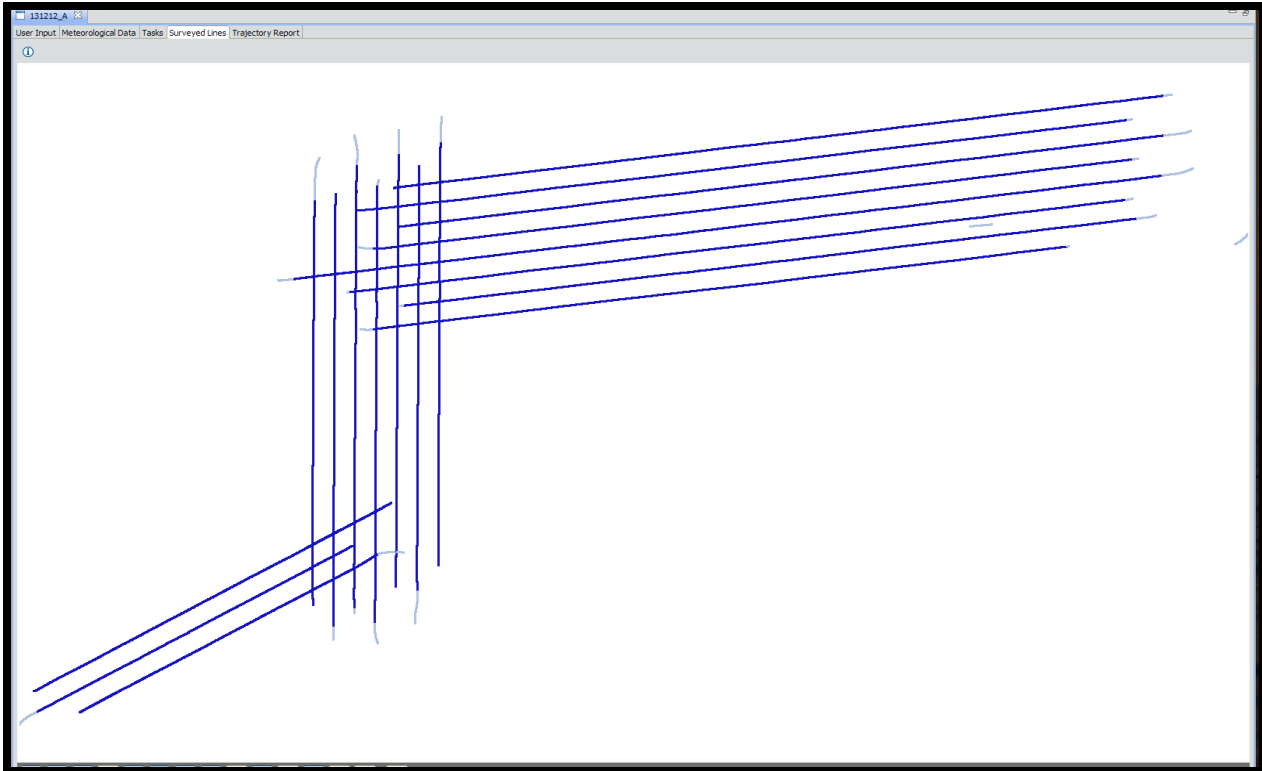

As in self-calibration the LMS production program analyses ground, roof planes and rooflines. One cross flight is locked in elevation and all other lines are adjusted to it. Unlike the calibration site the distribution of roof planes is usually much less dense. Here matched ground tie planes are blue.

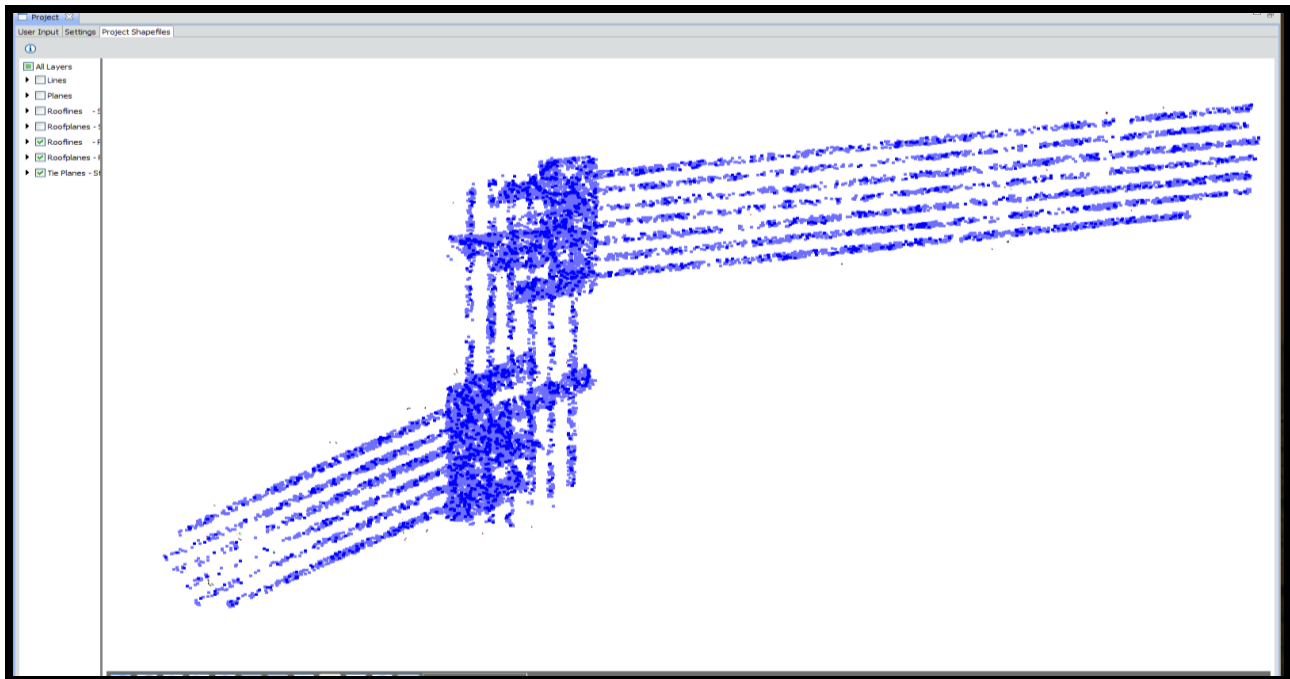

The same quality control outputs used to check self-calibrations are available to analyze the production run. Output plots are again available in LMS and cross sections plus a Flight Line Separation Raster are generated in MARS® to check coverage and quality.

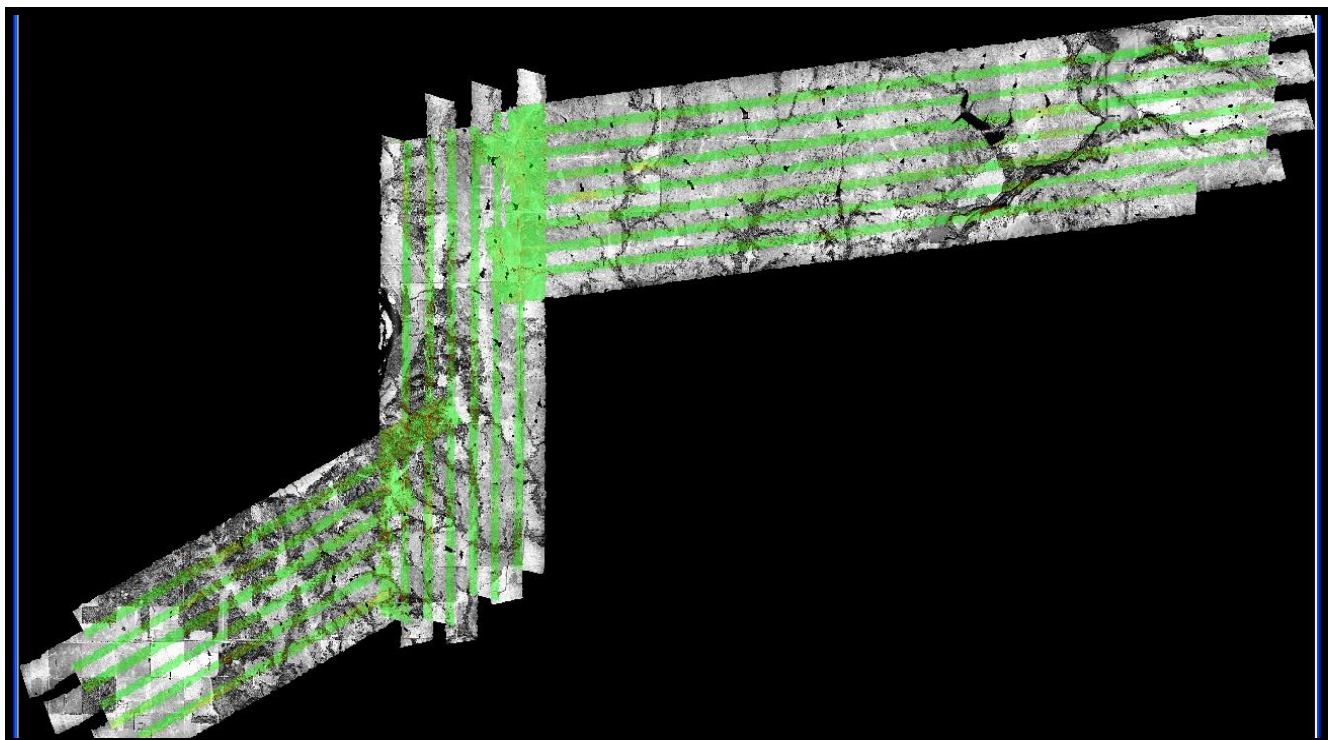

Correcting the Final Elevation

After all the lines are tied together a ground control network is imported into MARS®. The ground control network may be pre-existing or collected by a licensed surveyor.

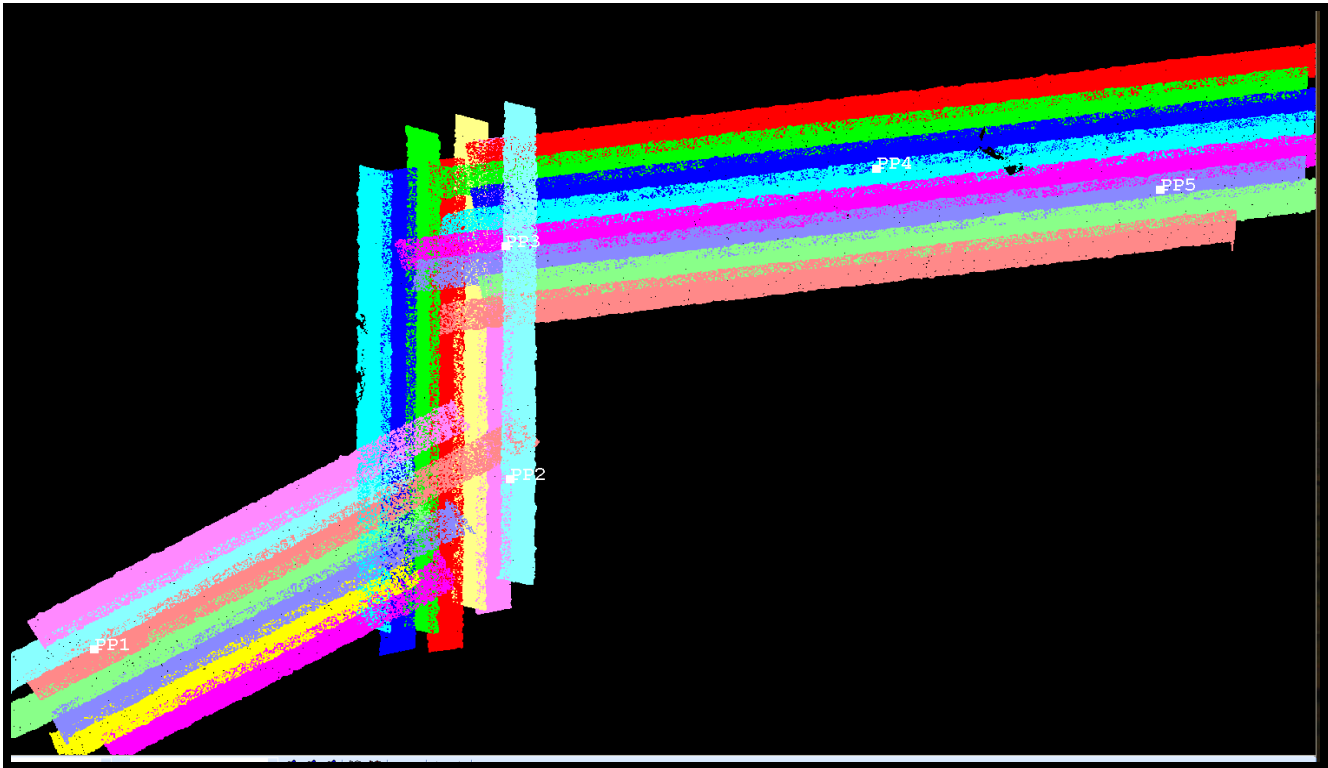

The next step is to match the ground control elevations to the lidar data set. A control report is run and the data set is shifted slightly to zero out the average elevation error and points checked for quality.

The final step before boresighted, leveled LAS files are ready for filtering is to run the MARS® QC Module on the block data. The Boresighted lidar QC Report outputs individual reports on Point Density, Nominal Pulse Spacing, Data Voids, Spatial Distribution, Scan Angles, Control Report, Flight Line Separation, Flight Line Overlap, Buffered Boundary, LAS Formats, Datums and Coordinates.

These reports are checked with the required specifications in the Project Management Plan.